



E90/ACCELERATOR SERIES ELECTRIC SCOOTER



⚠ NOTE: The unit must be traveling up to 3mph (5kmh) before motor will engage. Kick start up to 3mph (5kmh) while applying the throttle to engage motor.

OWNER'S MANUAL

**Read and understand this entire manual before riding!
DO NOT RETURN TO STORE!**

NOTE: Manual illustrations are for demonstration purposes only. Illustrations may not reflect exact appearance of actual product. Specifications subject to change without notice.

Please have your 19 digit product I.D. code ready before contacting Razor for warranty assistance and/or replacement parts.

Product I.D. Code: _____ - _____ - _____

CONTENTS

Safety Warnings	1	Hardware Maintenance	4
Before You Begin.....	2	Repair and Maintenance.....	5-6
Assembly and Set-Up.....	3	Troubleshooting Guide.....	7
Usage	4	Electric Scooter Parts	8
		Warranty	10

SAFETY WARNINGS

⚠ WARNING: Riding an electric scooter does present potential risks and caution is required. Like any riding product, an electric scooter has inherent hazards associated with its use (for example, falling off or riding it into a hazardous situation). Like any riding product, electric scooters can and are intended to move and it is therefore, of course, possible to lose control or otherwise get into dangerous situations. Both children and adults responsible for supervising them must recognize that, if such things occur, a rider can be seriously injured or die, even when using safety equipment and other precautions. **RIDE AT YOUR OWN RISK AND USE COMMON SENSE.**

⚠ WARNING: PARENTAL AND ADULT RESPONSIBILITY AND SUPERVISION IS NECESSARY: Because products like electric scooters can and do present potential hazards plainly associated with their use, it is well recognized the **THE NEED FOR THE EXERCISE OF PARENTAL RESPONSIBILITY IN SELECTING RIDING PRODUCTS APPROPRIATE TO THE AGE OF A CHILD, OR PARENTAL SUPERVISION IN SITUATIONS IN WHICH CHILDREN OF VARIOUS AGES MAY HAVE ACCESS TO THE SAME RIDING PRODUCTS, IS IMPORTANT.** Not every product is appropriate for every age or size of child and different age recommendations are found within this category of product, which are intended to reflect the nature of the hazards and the expected mental or physical ability, or both, of a child to cope with the hazards.

The recommended rider age is 8 and older. Any rider unable to fit comfortably on the scooter should not attempt to ride it. A parent's decision to allow his or her child to ride this product should be based on the child's maturity, skill and ability to follow rules.

Keep this product away from small children and remember that it is intended for use only by persons who are, at a minimum, completely comfortable and competent while operating the scooter.

Person with any mental or physical conditions that may make them susceptible to injury or impair their physical dexterity or mental capabilities to recognize, understand, and follow safety instructions and to be able to understand the hazards inherent in scooter use should not use, or be permitted to use, products inappropriate for their abilities. Persons with heart conditions, head, back or neck ailments (or prior surgeries to these areas of the body), or pregnant women, should be cautioned not to operate such products.

DO NOT EXCEED THE WEIGHT LIMIT OF 120lbs (54kg). Rider weight does not necessarily mean a person's size is appropriate to fit or maintain control of the scooter.

CHECK AND MAINTAIN SCOOTER CONDITIONS

Before use, check to confirm that any and all chain guards or other covers or guards are in place and in serviceable condition, that the brake is functioning properly, and that tires are inflated properly and have sufficient tread remaining. The scooter should be maintained and repaired in accordance with the manufacturer's specifications and using only the manufacturer's authorized replacement parts, and should not be modified from the manufacturer's original design and configuration.

ACCEPTABLE RIDING PRACTICES AND CONDITIONS

Always check and obey any local laws or regulations which may affect the locations where the electric scooter may be used. Keep safely away from cars and motor vehicle traffic at all times and only use where allowed and with caution.

Do not activate the speed control on the hand grip unless you are on the scooter and in a safe, outdoor environment suitable for riding. **The electric scooter must be moving at 3mph before the motor will engage.**

Maintain a hold on the handlebars at all times. Do not touch the brakes or motor on your scooter with fingers or bare hands when in use or immediately after riding as these parts can become very hot.

Ride defensively. Be careful to avoid pedestrians, skaters, skateboards, scooters, bikes, children or animals who may enter your path, and respect the rights and property of others.

The electric scooter is intended for use on flat, dry surfaces such as pavement or level ground without loose debris such as sand, leaves, rocks or gravel. Wet, slick, bumpy, uneven or rough surfaces may impair traction and contribute to possible accidents. Do not ride your scooter in mud, ice, puddles or water. Watch out for potential obstacles that could catch your wheel or force you to swerve suddenly or lose control. Avoid sharp bumps, drainage grates, and sudden surface changes.

Avoid excessive speeds that can be associated with downhill rides.

Do not attempt or do stunts or tricks on your electric scooter. The scooter is not made to withstand abuse from misuse such as jumping, curb grinding or any other type of stunts. Racing, stunt riding, or other maneuvers also enhance risk of loss of control, or may cause uncontrolled rider actions or reactions.

Never allow more than one person at a time to ride the scooter.

Do not ride at night or when visibility is limited.

Never use near steps or swimming pools.

Do not allow hands, feet, hair, body parts, clothing, or similar articles to come in contact with moving parts, wheels, or drivetrain, while the motor is running.

Never use headphones or a cell phone when riding.

Never hitch a ride with another vehicle.

Do not ride your scooter in wet or icy weather and never immerse the scooter in water, as the electrical and drive components could be damaged by water or create other possibly unsafe conditions. Never risk damaging surfaces such as carpet or flooring by use of an electric scooter indoors.

PROPER RIDING ATTIRE

Always wear proper protective equipment such as an approved safety helmet (with chin strap securely buckled), elbow pads and kneepads. A helmet may be legally required by local law or regulation in your area. A long-sleeved shirt, long pants, and gloves are recommended. Always wear athletic shoes (lace-up shoes with rubber soles), never ride barefooted or in sandals, and keep shoelaces tied and out of the way of the wheels, motor and drive system.

USING THE CHARGER

The charger supplied with the electric scooter should be regularly examined for damage to the cord, plug, enclosure and other parts, and in the event of such damage, the scooter must not be charged until the charger has been repaired or replaced.

Use only with the recommended charger.

Use caution when charging.

The charger is not a toy. Charger should be operated by an adult.

Do not operate charger near flammable materials.

Unplug charger and disconnect from scooter when not in use.

Do not exceed charging time.

Always disconnect from the charger prior to wiping down and cleaning your scooter with liquid.

FAILURE TO USE COMMON SENSE AND HEED THE ABOVE WARNINGS INCREASES RISK OF SERIOUS INJURY. USE WITH APPROPRIATE CAUTION AND SERIOUS ATTENTION TO SAFE OPERATION.

BEFORE YOU BEGIN

Remove contents from box. Remove the foam separators that protect the components from damage during shipping. Inspect the contents of the box for scratches in the paint, dents or kinked cables that may have occurred during shipping. Because the scooter was 95 percent assembled and packed at the factory, there should not be any problems, even if the box has a few scars or dents.

MAKE SURE POWER SWITCH IS TURNED "OFF" BEFORE CONDUCTING ANY MAINTENANCE PROCEDURES.

Estimated Assembly and Set-Up Time

Razor recommends assembly by an adult with experience in bicycle mechanics. Allow up to 10 minutes for assembly, not including initial charge time. Allow up to 12 hours for charge (see page 3 for charging information).

Charger

(Note: Charger design may vary from one shown)

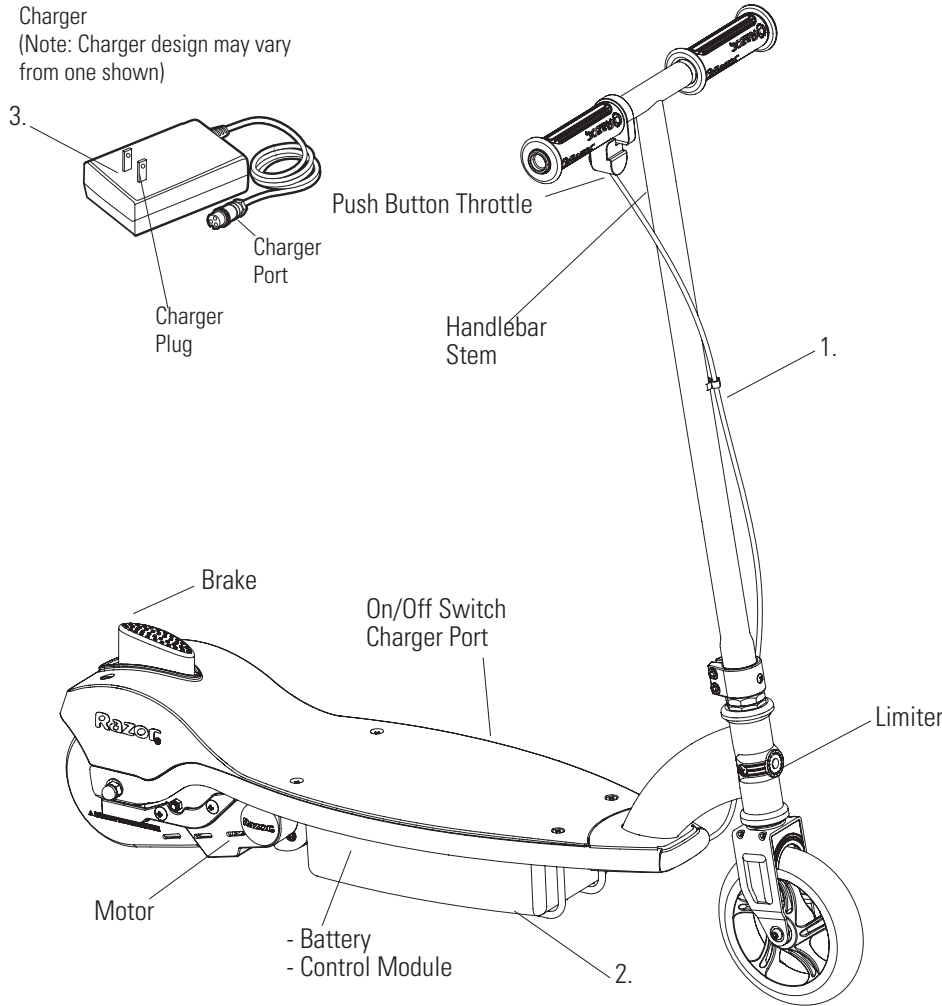

WARNING:
DO NOT USE NON-RAZOR PRODUCTS WITH YOUR RAZOR ELECTRIC SCOOTER.

The scooter has been built to certain Razor design specifications. The original equipment supplied at the time of sale was selected on the basis of its compatibility with the frame, fork and all other parts. Certain aftermarket products may not be compatible and will void the warranty.

Note: Electric scooter must be moving at 3mph/5kmh while pressing the push button throttle to engage motor.

Product ID Locations:

See locations to the left

1. Stem
2. Underneath battery tray
3. Charger
4. Box - side of UPC (not shown)

Required Tools

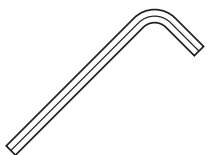

5mm Allen wrenches
(Included)

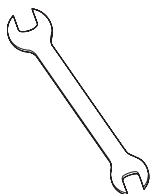

10mm and 13mm open
wrenches
(Not included)

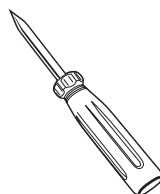

Screwdriver
(Not included)

Need Help? Visit our web site for replacement parts, product support and a list of authorized service centers at www.razor.com or call toll free 866-467-2967 Monday - Friday 8AM - 5PM Pacific Time. Please have the product I.D. code located on the white label on your product or back of charger available for better assistance.

ASSEMBLY AND SET-UP

□ Attaching the Handlebar Grip

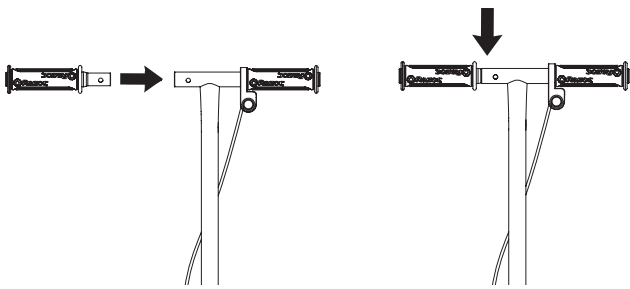

1 Insert and secure the collapsible handlebar by pressing the spring-loaded button and inserting it into the T-bar.

2 Make certain the spring-loaded button engages the hole and is properly locked into the T-bar.

□ Attaching the Handlebars

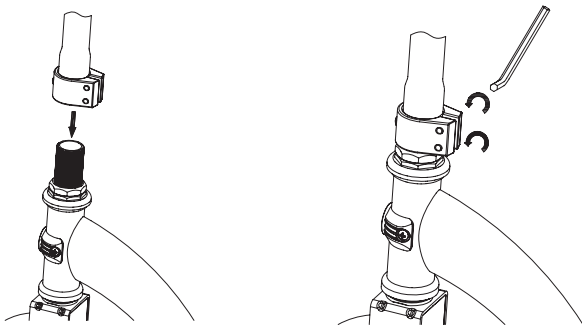

1 Loosen the collar clamp and slide it upward. With a clock-wise twisting motion, push and "thread" the steering tube onto the fork until it bottoms out on the fork headset lock nut.

2 With the front wheel pointed straight ahead and the handlebars square to the front wheel, tighten the clamp as shown. Tighten securely.

□ Charging the Battery

Your electric scooter may not have a fully charged battery. Therefore it is a good idea to charge the battery prior to use.

- Initial charge time: 12 hours
- Recharge time: up to 12 hours, even if the light turns green.
- Fully charge battery before storing.
- When the scooter is not in regular use, recharge the battery at least once a month until normal use is resumed.
- Make sure power is turned **OFF** when unit is not in use.
- Continue charging for the full 12 hours even if charge light indicates charging complete.
- Run time: Up to 40 minutes of continuous ride time. Run time may vary depending on riding conditions, climate and/or proper maintenance.
- Constant stopping and starting may shorten ride time.
- Average battery life for a properly maintained unit is approx. 250 charge/discharge cycles.
- To ensure long battery life, never store the product in freezing or below freezing temperatures! Freezing will permanently damage the battery. Failure to recharge the battery at least once a month may result in a battery that will no longer accept a charge.

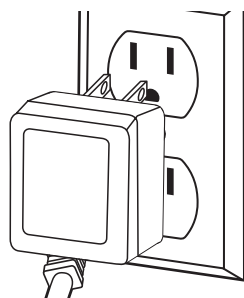
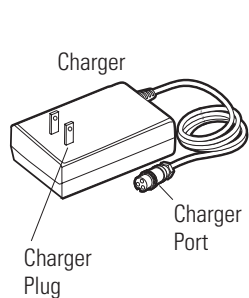

1 Plug the charger into a wall outlet. If the lights on charger do not light up, check the power to the outlet. If necessary, try a different outlet.

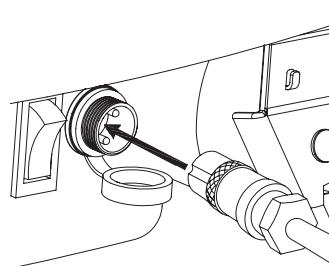

2 Turn power **OFF** before charging. Plug the charger into the charger port on the electric scooter.

! WARNING: Failure to properly engage the spring-loaded button may cause the handlebar to dislodge while riding and may cause you to lose control and fall. When correctly engaged, the handlebar will not rotate nor will it move sideways. Note that when properly engaged, the spring-loaded button is clearly visible in the hole on the T-tube.

Note: Make sure any cables/wires are out of the way before inserting the stem into the fork.

! WARNING: Always disconnect your scooter from the charger before cleaning with liquid.

Note: If your charger does not look like the one illustrated, your unit has been supplied with an alternative charger. The specifications and charging procedure would not change.

The charger has a small window with one LED to indicate the charge status. Refer to the illustration on the charger unit for the actual "charging" and "charged" status indications for your model charger.

Chargers have built-in over-charge protection to prevent battery from being over-charged.

Charger will get warm during use. This is normal for some chargers and is no cause for concern. If your charger does not get warm during use, it does not mean that it is not working properly.

! WARNING: Failure to recharge the battery at least once a month may result in a battery that will no longer accept a charge.

USAGE

Starting the Scooter

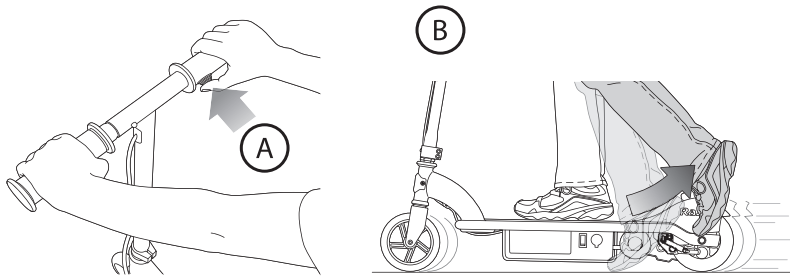

To start unit, turn on the power switch, press the push button throttle (A) and kick start up to 3mph (5kmh) (B).

Note: Electric scooter must be moving at 3mph/5kmh while pressing the push button throttle to engage motor.

Stopping the Scooter

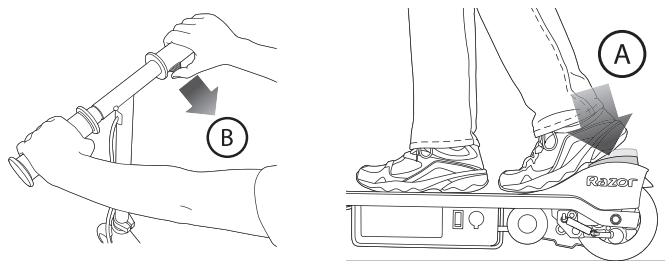

To stop unit, release the push button throttle (A) and step down on the rear fender brake (B) until the unit comes to a complete stop.

CONNECTORS/HARDWARE MAINTENANCE

Brake

Check the brakes for proper function. When you step on the brake, the brake should provide positive braking action. When you apply the brake with the speed control on, the brake cut-off switch should cut power to the motor.

Frame, Fork and Handlebars

Check for cracks or broken connections. Although broken frames are rare, it is possible for an aggressive rider to run into a curb or wall and wreck and bend or break a frame. Get in the habit of inspecting your scooter on a regular basis.

Wheels

Periodically inspect the tires for excess wear and regularly check the wheels.

Safety Gear

Always wear proper protective gear such as an approved safety helmet. Elbow pads and kneepads are recommended. Always wear athletic shoes (lace-up shoes with rubber soles), never ride barefooted or in sandals, and keep shoelaces tied and out of the way of the wheels, motor and drive system.

Battery

Make sure the power switch is turned off whenever the scooter is not in use. Never store the product in freezing or below freezing temperatures! Freezing will permanently damage the battery. Failure to recharge the battery at least once a month may result in a battery that will no longer accept a charge.



Do not use this product for the first time until you have charged the battery for at least 12 hours. Failure to follow these instructions may damage your product and void your warranty.

Need Help? Visit our web site for replacement parts, product support and a list of authorized service centers at www.razor.com or call toll free 866-467-2967 Monday - Friday 8AM - 5PM Pacific Time. Please have the product I.D. code located on the white label on your product or back of charger available for better assistance.

REPAIR AND MAINTENANCE

□ Front Wheel Replacement

Tools required: Two (2) 5mm Allen wrenches.

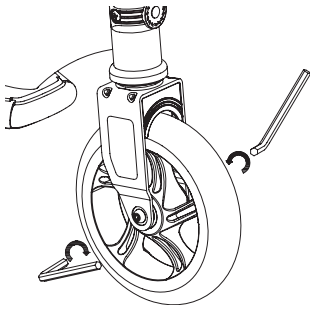

Note: Front wheel hardware sequence

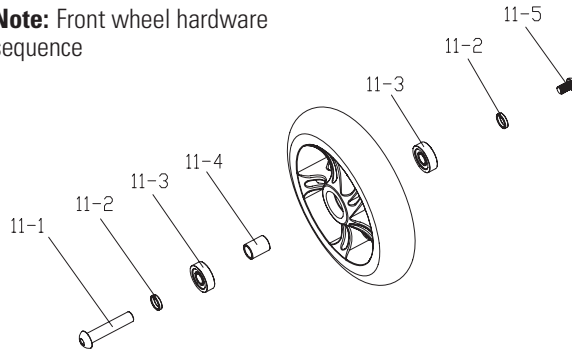

1 Using two (2) 5mm Allen wrenches, loosen the axle bolt. Remove wheel and install replacement wheel. (Note the sequence of the hardware)

Right Side

11-4 - Center spacer

11-3 - Bearing

11-2 - Spacer

Fork

11-1 - 5mm coupling bolt

Left Side

11-3 - Bearing

11-2 - Spacer

Fork

11-5 - 5mm coupling screw

□ Chain and Rear Wheel Replacement

Tools required: Phillips screwdriver, 10mm open wrench and two (2) 13mm open wrenches.

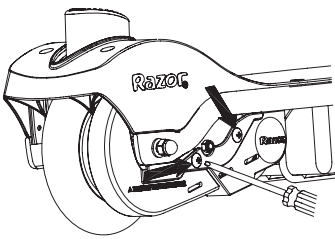

1 With a Phillips screwdriver, loosen the two screws and remove the chain guard.

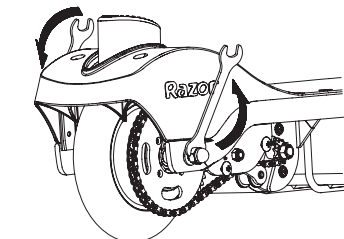

2 Using two 13mm open wrenches, loosen the locknuts by turning the wrenches counter clockwise.

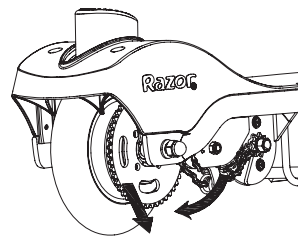

3 To loosen the chain, push the chain tensioner down to create some slack in the chain.

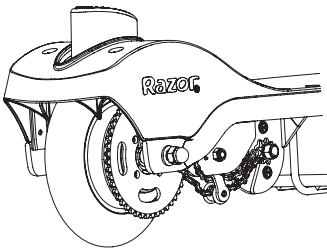

4 Remove wheel and install replacement wheel. (Note the sequence of the hardware)

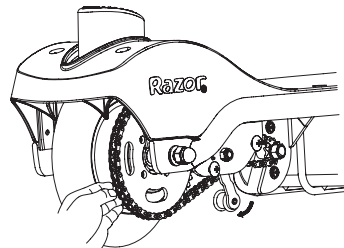

5 Push the chain tensioner down to install the chain on both sprockets.

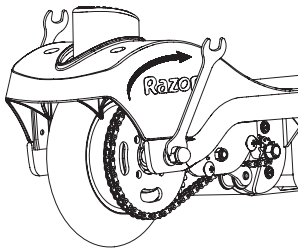

6 With two 13mm open wrenches, re-tighten the locknuts.

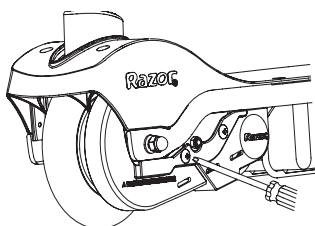

7 Re-attach the chain guard.

Note: Rear wheel hardware sequence

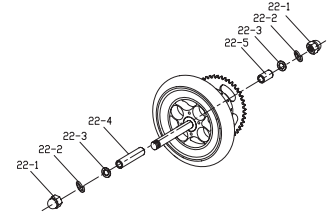

Left Side

22-1 13mm nut

22-2 Split washer

22-3 Flat washer

Frame

22-4 Long spacer

Right Side

22-1 13mm nut

22-2 Split washer

22-3 Flat washer

Frame

22-5 Short spacer

REPAIR AND MAINTENANCE

Battery Care and Disposal

Never store the product in freezing or below freezing temperatures! Freezing will permanently damage the battery. Failure to recharge the battery at least once a month may result in a battery that will no longer accept a charge.



CONTAINS SEALED LEAD ACID BATTERIES. BATTERIES MUST BE RECYCLED.

Disposal: Your Razor product uses sealed lead-acid batteries which must be recycled or disposed of in an environmentally safe manner. Do not dispose of a lead-acid battery in a fire. The battery may explode or leak. Do not dispose of a lead-acid battery in your regular household trash. The incineration, land filling or mixing of sealed lead-acid batteries with household trash is prohibited by law in most areas. Return exhausted batteries to a federal or state approved lead-acid battery recycler or a local seller of automotive batteries. If you live in Florida or Minnesota, it is prohibited by law to throw away lead-acid batteries in the municipal waste stream.

Charger

The charger supplied with the electric scooter should be regularly examined for damage to the cord, plug, enclosure and other parts and in the event of such damage, the product must not be charged until it has been repaired or replaced.

Use ONLY with the recommended charger.

Wheels

Wheels and drive system are subject to normal wear and tear. It is the responsibility of the user to periodically inspect wheels for excess wear and adjust and replace drive train components as required.

Replacement Parts

The most frequently requested replacement parts are available for purchase at some Razor retail partners. For the complete selection of replacement parts visit www.razor.com/shop.

Repair Centers

For a list of authorized Razor repair centers:

- Check online at www.razor.com.
- Call 866-467-2967 for the center nearest you.

WARNING: If a battery leak develops, avoid contact with the leaking acid and place the damaged battery in a plastic bag. Refer to the disposal instructions at left. If acid comes into contact with skin or eyes, flush with cool water for at least 15 minutes and contact a physician.

WARNING: Battery posts, terminals and related accessories contain lead and lead compounds. **Wash your hands after handling.**

Need Help? Visit our web site for replacement parts, product support and a list of authorized service centers at www.razor.com or call toll free 866-467-2967 Monday - Friday 8AM - 5PM Pacific Time. Please have the product I.D. code located on the white label on your product or back of charger available for better assistance.

TROUBLESHOOTING GUIDE

Unit should be fully charged prior to doing any troubleshooting and must be done by an adult ONLY.

Problem	Possible Cause	Solution
Does not work out of the box	Unit must be traveling up to 3mph before motor will engage	Kickstart to 3mph while pressing the push button throttle to engage motor.
	Loose connection(s)	Check for loose connections/wires underneath the deck plate.
No longer works	Blown fuse	Check fuse; replace if needed.
	Loose connection(s)	Check for loose connections/wires underneath the deck plate.
	No lights on charger	Check power to wall outlet and/or try a different outlet.
	Undercharged battery	Check lights on charger: Plugged into wall = Green Plugged into wall & unit = Red Charging Complete = Green No lights/Blinking lights - Replace Charger
	Battery will not hold a charge	With no weight on the unit, lift up back end; manually (and carefully, of course) spin rear wheel and press push button throttle to engage the motor. If motor engages - replace battery.
Short run time/runs slow	Riders weight	Do not exceed 120 lbs maximum weight limit.
	Riding conditions	Use only on flat, dry surfaces. Avoid inclines and areas with heavy debris.
	Battery not fully charged	Charge unit for a full 12 hours.
	Old/damaged battery	With no weight on the unit, lift up back end; manually (and carefully, of course) spin rear wheel and press push button throttle to engage the motor. If motor engages - replace battery.
		Charge battery at least once a month when not in use. Do not store unit in freezing or below freezing temperatures. Freezing will permanently damage the battery and greatly reduce ride time. Refer to Pg. 3 Charging the Battery.
Runs intermittently	Loose connection(s)	Check the wires around the throttle and connectors underneath the deck plate. Replace - push button throttle.

For a list of available replacement parts or to locate an authorized Service Center in your area, visit our website at www.razor.com or call toll free 866-467-2967 to speak to a live Customer Service Representative

E90 ELECTRIC SCOOTER PARTS

Keep your scooter running for years with genuine Razor parts. Visit our website or e-mail us for more information on spare part availability. (Specifications subject to change without notice.)

- | | | | |
|----|-----------------------------------|----|-----------------------------------|
| 01 | Elastic cord w/end cap | 12 | Charger port |
| 02 | Handlebar grips (right/left) | 13 | Kickstand |
| 03 | Push button throttle | 14 | Brake fender pedestal |
| 04 | Handlebar stem | 15 | Chain tensioner |
| 05 | Collar clamp | 16 | Motor (12V / 100W) |
| 06 | Headset (upper/lower) | 17 | Rear brake fender |
| 07 | Front fork w/limiter | 18 | Rear wheel complete |
| 08 | Front wheel complete | | (See pg. 5 for hardware sequence) |
| | (See pg. 5 for hardware sequence) | 19 | Chain |
| 09 | Battery tray | 20 | Chain guard |
| 10 | Control module | 21 | Battery (1-12V/7Ah) w/fuse |
| 11 | On/off switch | 22 | Deck plate |

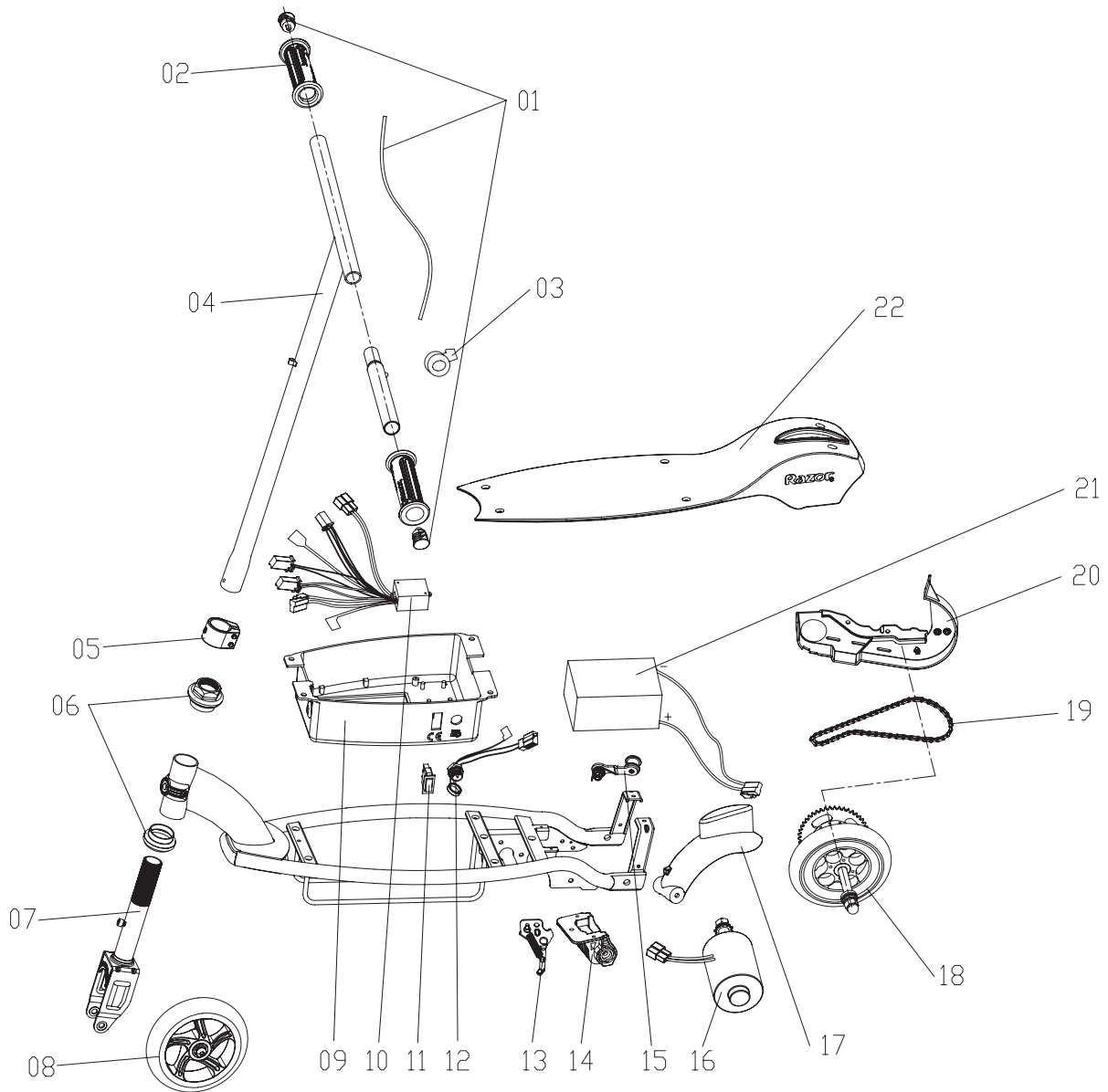

Need Help? Visit our web site for replacement parts, product support and a list of authorized service centers at www.razor.com or call toll free 866-467-2967 Monday - Friday 8AM - 5PM Pacific Time. Please have the product I.D. code located on the white label on your product or back of charger available for better assistance.

SB 1918 (CALIFORNIA) DECLARATION

YOUR INSURANCE POLICIES MAY NOT PROVIDE COVERAGE FOR ACCIDENTS INVOLVING THE USE OF THIS SCOOTER/ELECTRIC RIDE-ON PRODUCT. TO DETERMINE IF COVERAGE IS PROVIDED, YOU SHOULD CONTACT YOUR INSURANCE COMPANY OR AGENT.

WARRANTY

Razor Limited Warranty

The manufacturer warrants this product to be free of manufacturing defects for a period of 90 days from date of purchase. This Limited Warranty does not cover normal wear and tear, tires, tubes or cables, or any damage, failure or loss caused by improper assembly, maintenance, or storage or use of the Razor E90/Accelerator series electric scooter.

This Limited Warranty will be void if the product is ever

- used in a manner other than for recreation or transportation
- modified in any way;
- rented.

The manufacturer is not liable for incidental or consequential loss or damage due directly or indirectly to the use of this product.

Razor does not offer an extended warranty. If you have purchased an extended warranty, it must be honored by the store at which it was purchased.

For your records, save your original sales receipt with this manual and write the serial number below.

Need Help? Visit our web site for replacement parts, product support and a list of authorized service centers at www.razor.com or call toll free 866-467-2967 Monday - Friday 8AM - 5PM Pacific Time. Please have the product I.D. code located on the white label on your product or back of charger available for better assistance.

Printed in China for:
Razor USA LLC
PO Box 3610
Cerritos, CA 90703

Copyright © 2003-2012 Razor USA LLC. All rights reserved. RAZOR and the Razor Logo Design are among the registered trademarks of Razor USA LLC in the United States and/or select foreign countries.

08/2012