



*packet mod*™



# OWNER'S MANUAL

**Read and understand this entire manual before riding!  
DO NOT RETURN TO STORE!**

**NOTE: Manual illustrations are for demonstration purposes only. Illustrations may not reflect exact appearance of actual product. Specifications subject to change without notice.**

# CONTENTS

Safety Warnings .....	1	Troubleshooting Guide.....	8
Before You Begin.....	2	Pocket Mod Parts.....	9
Assembly and Set-Up.....	3-4	Safety Reminders.....	11
Before Riding.....	4	Warranty .....	11
Repair and Maintenance.....	5-7		

## SAFETY WARNINGS

**⚠ WARNING:** Riding the Pocket Mod can be a hazardous activity. Certain conditions may cause the equipment to fail without fault of the manufacturer. Like other electric products, the Pocket Mod can and is intended to move, and it is therefore possible to lose control, fall off and/or get into dangerous situations that no amount of care, instruction or expertise can eliminate. If such things occur you can be seriously injured or die, even when using safety equipment and other precautions. **RIDE AT YOUR OWN RISK AND USE COMMON SENSE.**

This manual contains many warnings and cautions concerning the consequences of failing to maintain, inspect or properly use your Pocket Mod. Because any incident can result in serious injury or even death, we do not repeat the warning of potential serious injury or death each time such a possibility is mentioned.

### APPROPRIATE RIDER USE AND PARENTAL SUPERVISION

This manual contains important safety information. It is your responsibility to review this information and make sure that all riders understand all warnings, cautions, instructions and safety topics and assure that young riders are able to safely and responsibly use this product. Razor recommends that you periodically review and reinforce the information in this manual with younger riders, and that you inspect and maintain your children's product to insure their safety.

The recommended rider age of 13 and older for the Pocket Mod is only an estimate and can be affected by the rider's size, weight or skills. Any rider unable to fit comfortably on the Pocket Mod should not attempt to ride it. **A parent's decision to allow his or her child to ride this product should be based on the child's maturity, skill and ability to follow rules.**

Keep this product away from small children and remember that this product is intended for use only by persons who are, at a minimum, completely comfortable and competent while operating the product.

**DO NOT EXCEED THE WEIGHT LIMIT OF 170lbs (77kg).** Rider weight does not necessarily mean a person's size is appropriate to fit or maintain control of the Pocket Mod.

Do not touch the motor on your Pocket Mod when in use as it can become very hot.

Refer to the section on safety for additional warnings.

### ACCEPTABLE RIDING PRACTICES AND CONDITIONS

Always check and obey any local laws or regulations which may affect the locations where the Pocket Mod may be used on public property. The Pocket Mod is meant to be used only in controlled environments free of potential traffic hazards and not on public streets or sidewalks. Do not ride your Pocket Mod in any areas where pedestrian traffic is present.

Ride defensively. Watch out for potential objects that could catch your wheel or force you to swerve suddenly or lose control. Be careful to avoid pedestrians, skaters, skateboards, scooters, bikes, children or animals who may enter your path, and respect the rights and property of others.

Do not attempt or do stunts or tricks on your Pocket Mod. The Pocket Mod is not made to withstand abuse from misuse such as jumping, curb grinding or any other type of stunts.

Maintain a hold on the handlebars at all times.

Never carry passengers or allow more than one person at a time to ride the Pocket Mod.

Never use near steps or swimming pools.

Keep your fingers and other body parts away from the drive chain, steering system, wheels and all other moving components.

Never use headphones or a cell phone when riding.

Never hitch a ride with another product.

Do not ride the Pocket Mod in wet weather and never immerse the Pocket Mod in water, as the electrical and ride components could be damaged by water or create other possibly unsafe conditions.

The Pocket Mod is intended for use on solid, flat, clean and dry surfaces such as pavement or level ground without loose debris such as rocks or gravel. Wet, slick or uneven and rough surfaces may impair traction and contribute to possible accidents. Do not ride the Pocket Mod in mud, ice, puddles or water. Avoid excessive speeds that can be associated with downhill rides. Never risk damaging surfaces such as carpet or flooring by use of a Pocket Mod indoors.

Do not ride at night or when visibility is impaired.

### PROPER RIDING ATTIRE

Always wear proper protective equipment such as an approved safety helmet, elbow pads and kneepads. A helmet may be legally required by local law or regulation in your area. Always wear shoes, never ride barefooted or in sandals, and keep shoelaces tied and out of the way of the wheels, motor and drive system.

### USING THE CHARGER

The charger supplied with the Pocket Mod should be regularly examined for damage to the cord, plug, enclosure and other parts, and in the event of such damage, the product must not be charged until the charger has been repaired or replaced.

Use only with the recommended charger.

Use caution when charging.

The charger is not a toy. Charger should be operated by an adult.

Do not operate charger near flammable materials.

Unplug charger and disconnect from the battery operated product when not in use.

Always disconnect from the charger prior to wiping down and cleaning your Pocket Mod with liquid.

**FAILURE TO USE COMMON SENSE AND HEED THE ABOVE WARNINGS INCREASES RISK OF SERIOUS INJURY. USE WITH APPROPRIATE CAUTION AND SERIOUS ATTENTION TO SAFE OPERATION.**

# BEFORE YOU BEGIN

Remove contents from box. Remove the plastic separators that protect the components from damage during shipping. Inspect the contents of the box for scratches in the paint, dents or kinked cables that may have occurred during shipping. Because the Pocket Mod is 95 percent assembled and packed at the factory, there should not be any problems, even if the box has a few scars or dents.

## Estimated Assembly and Set-Up Time

Razor recommends assembly by an adult.

Allow up to 15 minutes for assembly.

Allow up to 12 hours for initial charge (see page 4 for charging information).



### WARNING:

DO NOT USE NON-RAZOR PRODUCTS WITH YOUR RAZOR POCKET MOD.

The Pocket Mod has been built to certain Razor design specifications. The original equipment supplied at the time of sale was selected on the basis of its compatibility with the frame, fork and all other parts. Certain aftermarket products may or may not be compatible and may void your warranty.

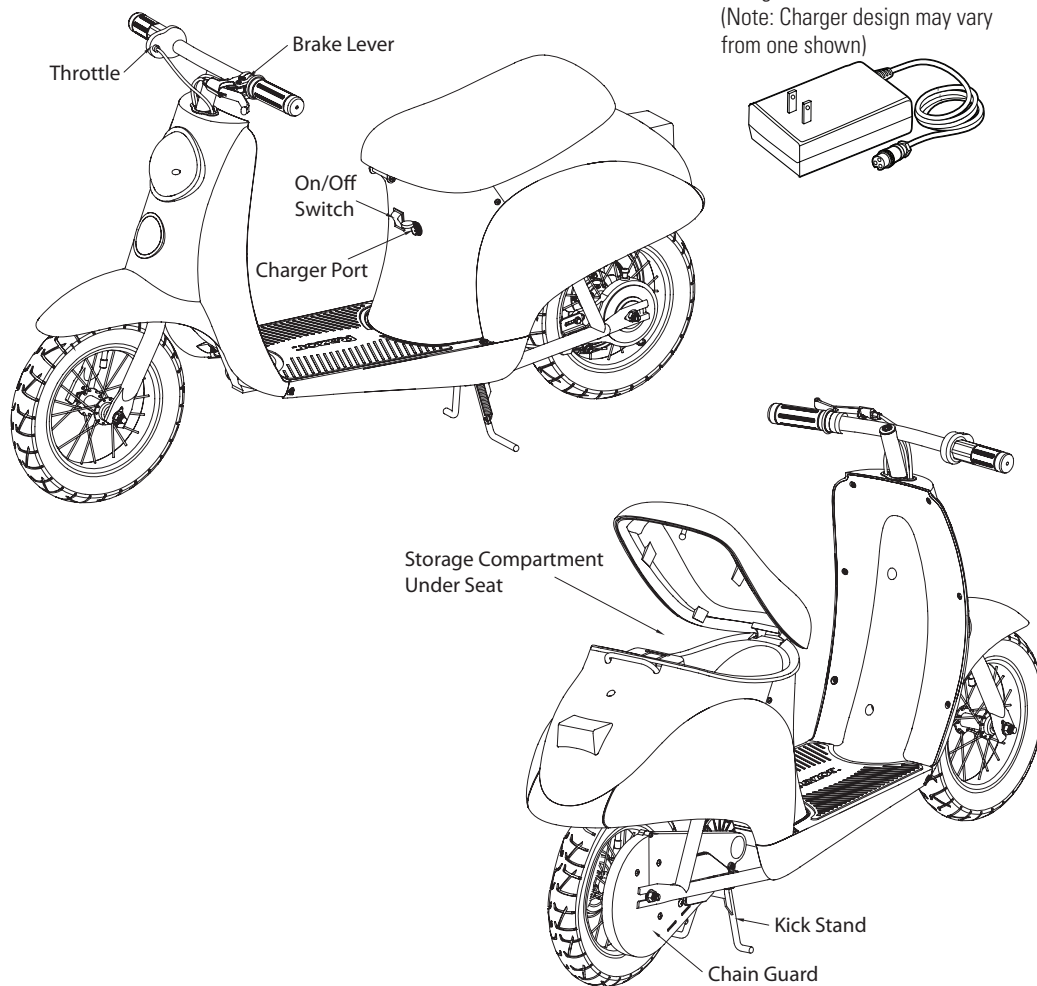

## Required Tools

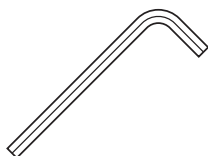

3mm, 5mm and 6mm  
Allen wrenches  
(Included)



14mm (Daisy only)  
and 15mm open wrenches  
(Included)  
8mm and 10mm open wrenches  
(Not Included)

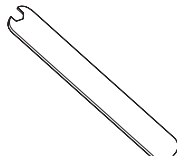

Spoke tightener  
(Included)

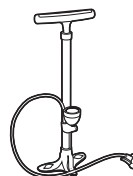

Bicycle tire pump for  
Schrader valves, with  
pressure gauge  
(Not Included)

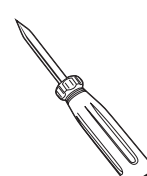

Phillips screwdriver  
(Not Included)

**Need Help?** Visit our website for updates and a list of authorized service centers at [www.razor.com](http://www.razor.com) or call toll-free at 866-467-2967 Monday - Friday 8:00 AM - 5:00 PM Pacific Time.

# ASSEMBLY AND SET-UP

## □ Attaching the Handlebars

**Tools required:** One (1) 6mm Allen wrench.



**1** Remove plastic protector and insert handlebar assembly through front fairing and into fork until it stops. Raise to desired height keeping the handlebars and fairing aligned within the red arrows of the safety zone.

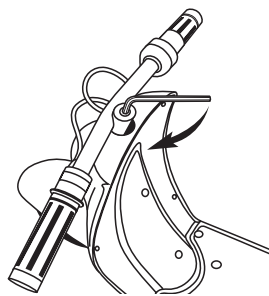

**2** Tighten down the hexagonal bolt with the 6mm Allen wrench.

## □ Attaching the Front Wheel

**Tools required:** Two (2) 15mm open wrenches.

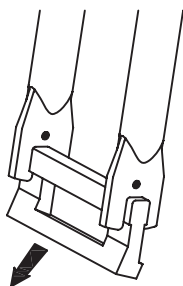

**1** Remove the plastic packing material from the front fork.

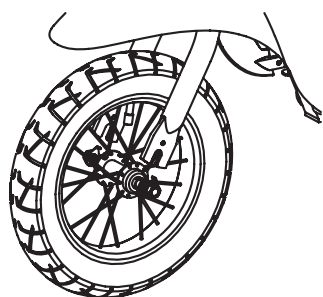

**2** Insert the wheel into the front fork with the lock washers on the outside of the fork.

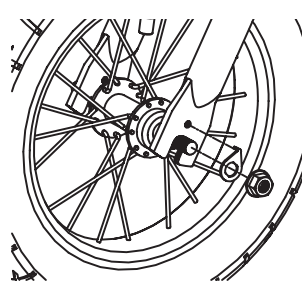

**3** Insert the tab on the lock washer into the hole on the front fork and tighten the nuts using two 15mm open wrenches.

## □ Checking Spoke Tension

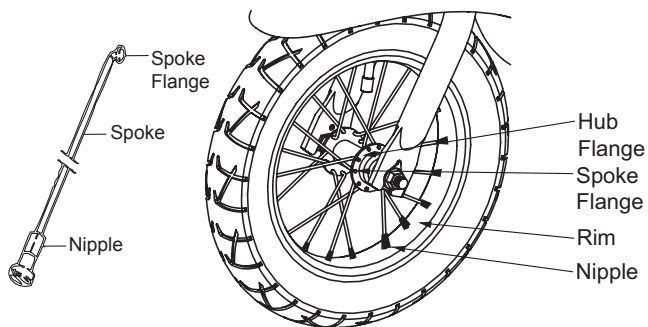

**1** Verify spoke tension by grasping and shaking each spoke. Spoke should not be loose from hub. Look for any play between spoke flanges where it mates with hub. Try to turn nipple using your fingers. You should not be able to spin any nipple by hand. If one or more spokes are loose, or if you can turn any nipple using your fingers, all spokes must be checked and need to be tightened with a spoke wrench.

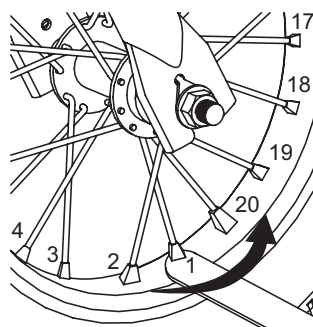

**2** Start with spoke closest to tire valve and tighten each nipple. In sequence, exactly 1/4 to 1/2 turn. A single 1/4 to 1/2 turn may not be enough to bring the spokes into proper tension. Continue tightening all spokes no more than 1/2 turn in sequence until all spokes are tight.

**Note:** Make sure the brake cables/wires are out of the way before inserting the stem into the fork.

**! WARNING:** Regularly check the spoke tension and retighten the spokes whenever loose. If you have any doubt, ask an experienced motorcycle or bicycle mechanic to inspect your spokes to determine if the spokes need tightening or adjusting.

**Note:** Tightening each nipple more than a 1/2 turn each can cause the wheel to become distorted and wobbly thus permanently damaging the wheel.



## ASSEMBLY AND SET-UP

### □ Inflating the Tires

Tires are inflated when shipped, but they invariably lose some pressure between the point of manufacturing and your purchase.

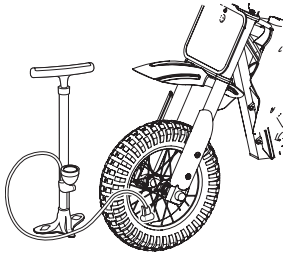

**1** Using a bicycle tire pump equipped for a Schrader valve, inflate the tires to the PSI indicated on the sidewall of the tires.

## BEFORE RIDING

### □ Charging the Battery

Your Pocket Mod may not have a fully charged battery; therefore it is a good idea to charge the battery prior to use.

- Initial charge time: 12 hours
- Recharge time: up to 12 hours, depending on level of depletion.
- Fully charge battery before storing.
- When the scooter is not in regular use, recharge the battery at least once a month until normal use is resumed.
- Run time: Up to 30 minutes of continuous ride time. Run time may vary depending on riding conditions, climate and/or proper maintenance.
- Average battery life: 250 charge/discharge cycles
- To ensure long battery life, do not store the battery in temperatures above 75° or below -10° F.

Charger

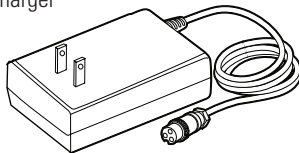

**Note:** Make sure power is turned **OFF** when unit is not in use. If the power switch is left on for an extended period of time, the battery may reach a stage at which it will no longer hold a charge.

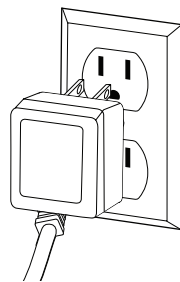

**1** Plug the charger into a wall outlet. If the lights on charger do not light up, check the power to the outlet. If necessary, try a different outlet.

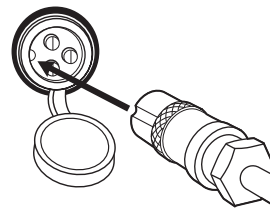

**2** Turn power **OFF** before charging. Plug the charger into the charger port to charge unit.

### ⚠ **WARNING:**

Rechargeable batteries are only to be charged under adult supervision. Always disconnect your Pocket Mod from the charger before cleaning with liquid.

**Note:** If your charger does not look like the one illustrated, your unit has been supplied with an alternative charger. The specifications and charging procedure would not change.

The charger has a small window with one LED to indicate the charge status. Refer to the illustration on the charger unit for the actual "charging" and "charged" status indications for your model charger.

Chargers have built-in over-charge protection to prevent battery from being over-charged.

Charger will get warm during use. This is normal for some chargers and is no cause for concern. If your charger does not get warm during use, it does not mean that it is not working properly.

⚠ **WARNING:** Failure to recharge the battery at least once a month may result in a battery that will no longer hold a charge.

**Need Help?** Visit our website for updates and a list of authorized service centers at [www.razor.com](http://www.razor.com) or call toll-free at 866-467-2967 Monday - Friday 8:00 AM - 5:00 PM Pacific Time.

# REPAIR AND MAINTENANCE

Turn power "OFF" before conducting any maintenance procedures.

## Testing the Brakes

To use the brake, squeeze the lever to increase the pressure on the brake. The brake lever is fitted with a cable adjuster to compensate for cable stretch and/or to fine-tune the lever movement to brake engagement. If brake is not engaging properly, follow instructions for adjusting the brakes.

### □ Adjusting the Brakes

**Tools required:** 10mm open wrench

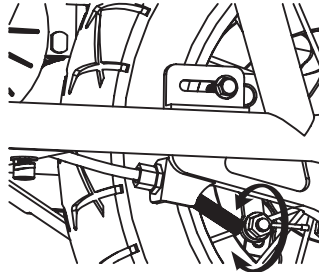
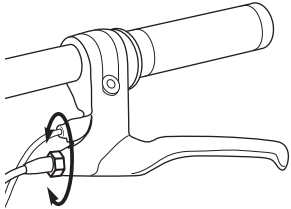

**1** To adjust the tension, thread the brake lever adjuster on the hand brake in or out 1/4 to 1/2 turn until the desired brake adjustment is attained. Most adjustments are complete at this step. If brake still needs further adjustment, proceed to step 2.

**2** If brake is too tight or has too much slack, use a 10mm open wrench to loosen the nut for additional adjustment on the brake cable on the rear wheel. Securely tighten nut when done.

### □ Chain and Rear Tire Replacement

**Tools required:** Phillips screwdriver, 10mm open wrench, two (2) 8mm open wrenches, and two (2) 15mm open wrenches.

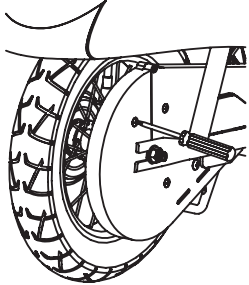

**1** With a Phillips screwdriver, remove the screws that secure the chain guard. Remove chain guard.

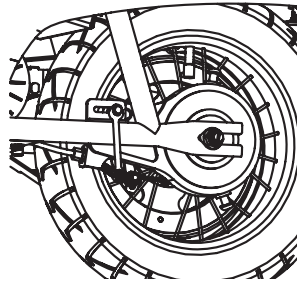

**2** With two 8mm open wrenches, loosen brake housing anchor and disconnect. Keep the spacer and washers together.

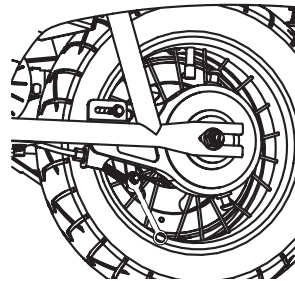

**3** With a 10mm open wrench, loosen the brake cable anchor and disconnect the cable.

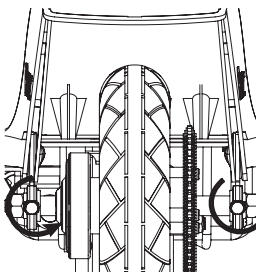

**4** With two 15mm open wrenches, loosen the axle. Slide the wheel forward to loosen the chain and remove the wheel. Note the sequence of the hardware.

**Note:** Your hands will get greasy doing this.

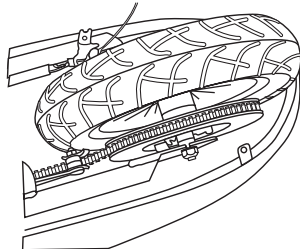

**5** Install the new chain or wheel by slipping the chain around the axle. Slide the axle into the slots on the frame. Slide the wheel forward and maneuver the chain onto the rear sprocket, motor shaft and chain tensioner.

**⚠ WARNING:** The brake is capable of skidding the tire and throwing an unsuspecting rider. Practice in an open area free from obstacles until you are familiar with the brake function. Avoid skidding to a stop as this can cause you to lose control or damage the rear tire.

**Note:** The brake lever contains a safety switch to cut power to the motor when the brake is applied. In an emergency, applying the brake will always stop the product from moving. Do not disable or replace this lever with anything other than a genuine Razor replacement part.

Note the sequence of the hardware:

#### **Right Side (Throttle)**

Safety hook  
3/8 Axle locknut

#### **Left Side (Brake)**

Spacer  
Safety hook  
3/8 Axle locknut

## REPAIR AND MAINTENANCE

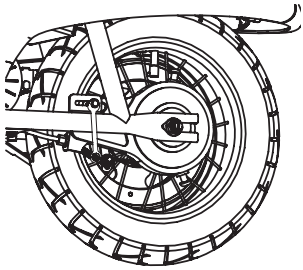

**7** Tighten the brake housing anchor securely.

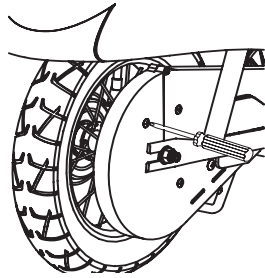

**8** Re-attach the chain guard. Test ride and readjust as needed.

### □ Replacing the Fuse

**Tools required:** Phillips screwdriver

**Turn power switch OFF.**

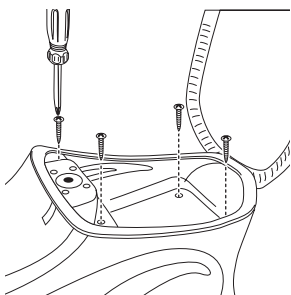

**1** Lift up the seat and unscrew the four (4) Phillips head screws in the storage compartment and remove the tray.

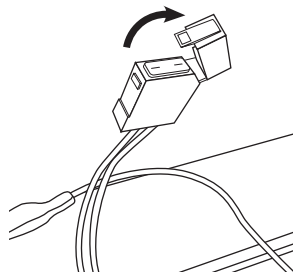

**2** Locate fuse box on top of battery. Open the fuse cover to expose the fuse.

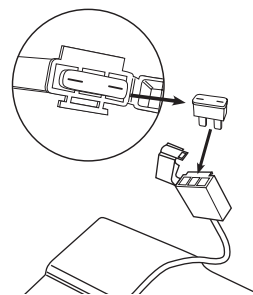

**3** Remove the fuse and replace with a new one of equal amperage.

**Note:** Amperage rating is located on top of fuse.

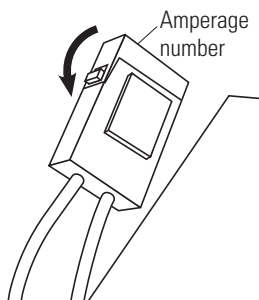

**4** Close the fuse box. Replace seat/storage compartment with the four (4) Phillips head screws.

### **!** WARNING:

To prevent shock, please follow the instructions accordingly and do not skip or combine any steps.

## REPAIR AND MAINTENANCE

### ❑ Battery Care and Disposal

Do not store the battery in temperatures above 75° or below -10° F.



CONTAINS SEALED LEAD ACID BATTERIES. BATTERIES MUST BE RECYCLED.

**Disposal:** Your Razor product uses sealed lead-acid batteries which must be recycled or disposed of in an environmentally safe manner. Do not dispose of a lead-acid battery in a fire. The battery may explode or leak. Do not dispose of a lead-acid battery in your regular household trash. The incineration, land filling or mixing of sealed lead-acid batteries with household trash is prohibited by law in most areas. Return exhausted batteries to a federal or state approved lead-acid battery recycler or a local seller of automotive batteries. If you live in Florida or Minnesota, it is prohibited by law to throw away lead-acid batteries in the municipal waste stream.

### ❑ Charger

The charger supplied with the electric scooter should be regularly examined for damage to the cord, plug, enclosure and other parts and in the event of such damage, the product must not be charged until it has been repaired or replaced.

Use ONLY with the recommended charger.

### ❑ Wheels

Wheels and drive system are subject to normal wear and tear. It is the responsibility of the user to periodically inspect wheels for excess wear and adjust and replace drive train components as required.

### ❑ Replacement Parts

For the complete selection of replacement parts visit [www.razor.com](http://www.razor.com).

### ❑ Repair Centers

For a list of authorized Razor repair centers:

- Check online at [www.razor.com](http://www.razor.com).
- Call 866-467-2967 for the center nearest you.

**⚠ WARNING:** If a battery leak develops, avoid contact with the leaking acid and place the damaged battery in a plastic bag. Refer to the disposal instructions at left. If acid comes into contact with skin or eyes, flush with cool water for at least 15 minutes and contact a physician.

**⚠ WARNING:** Battery posts, terminals and related accessories contain lead and lead compounds. **Wash your hands after handling.**



# TROUBLESHOOTING GUIDE

<b>Problem</b>	<b>Possible Cause</b>	<b>Solution</b>
Product does not run	Undercharged battery	Charge the battery. A new battery should be charged for at least 12 hours before using the product for the first time and up to 12 hours after each subsequent use.  Check all connections. Make sure the charger port is tightly plugged into the charging port on the Pocket Mod, and that the charger is plugged into the wall.
	Loose wires or connectors	Check all wires and connectors to make sure they are tight.
Product suddenly stopped working while in use	Burned out fuse	The fuse will burn out and automatically shut off the power if the motor is overloaded.  An excessive overload, such as too heavy a rider or too steep a hill, could cause the motor to overheat. Replace the fuse with a new one of equal amperage. Correct the conditions that caused the fuse to burn out and avoid repeatedly burning out fuse.
	Motor or electrical switch damage	Contact your local Razor authorized service center for diagnosis and repair.
Short run time (less than 15 minutes per charge)	Undercharged battery	Charge the battery. A new battery should have been charged for at least 12 hours before using the product for the first time and up to 12 hours after each subsequent use.  Check all wires and connectors. Make sure the battery connector is tightly plugged into the charger connector and that the charger is plugged into the wall.
	Tires are not properly inflated	The tires are inflated when shipped but invariably will lose some pressure between the point of manufacturing and your purchase. Refer to instruction on page 4.
	Brakes are not adjusted properly	Refer to adjusting the brakes instructions on page 5.
Product runs sluggishly	Riding conditions are too stressful	Use only on solid, flat, clean and dry surfaces such as pavement or level ground.
	Tires are not properly inflated	The tires are inflated when shipped but they invariably will lose some pressure between the point of manufacturing and your purchase. Refer to instructions on page 4.
	Product is overloaded	Make sure you do not overload the product by allowing more than one rider at one time, exceeding the 170 lb. maximum weight limit, going up a hill or towing objects behind the product.
	Brakes are not adjusted properly	Refer to adjusting the brakes instructions on page 5.
Sometimes the product doesn't run, but other times it does	Loose wires or connectors	Check all wires around the motor and all connectors to make sure they are tight.
	Motor or electrical switch damage	Contact your local Razor authorized service center for diagnosis and repair.
Product makes loud noises or grinding sounds	Chain is too dry	Apply a lubricant such as 3 in 1™ or Tri-Flow™ to the chain.

# POCKET MOD PARTS

Keep your Pocket Mod running for years with genuine Razor parts. Visit our web site or e-mail us for more information on spare part availability. (Specifications subject to change without notice.)

01	Handlebar Grip (Right/Left)	08	Front Wheel Complete	17	Footrest
02	Single Speed Twist Grip Throttle	09	Front Fork	18	Kickstand
02-1	Sleeve	10	Front Seat Fairing	19	Motor (24V 250W)
03	Handlebar	11	On/Off Switch	20	Rear Wheel Complete
04	6mm Stem Bolt with Wedge	12	Charger Port		(See page 5 for hardware sequence)
05	Brake Lever Assembly	13	Battery (2-12V/7Ah)	21	Chain
06	Headset (Upper/Lower)	14	Seat Storage Compartment	22	Chain Guard
07	Front Fairing w/Head Lamp Cover	15	30 Amp Fuse	23	Chain Tensioner
07-1	Front Fairing Cover	16	Control Module	24	Rear Seat Fairing w/Trim (Right/Left)

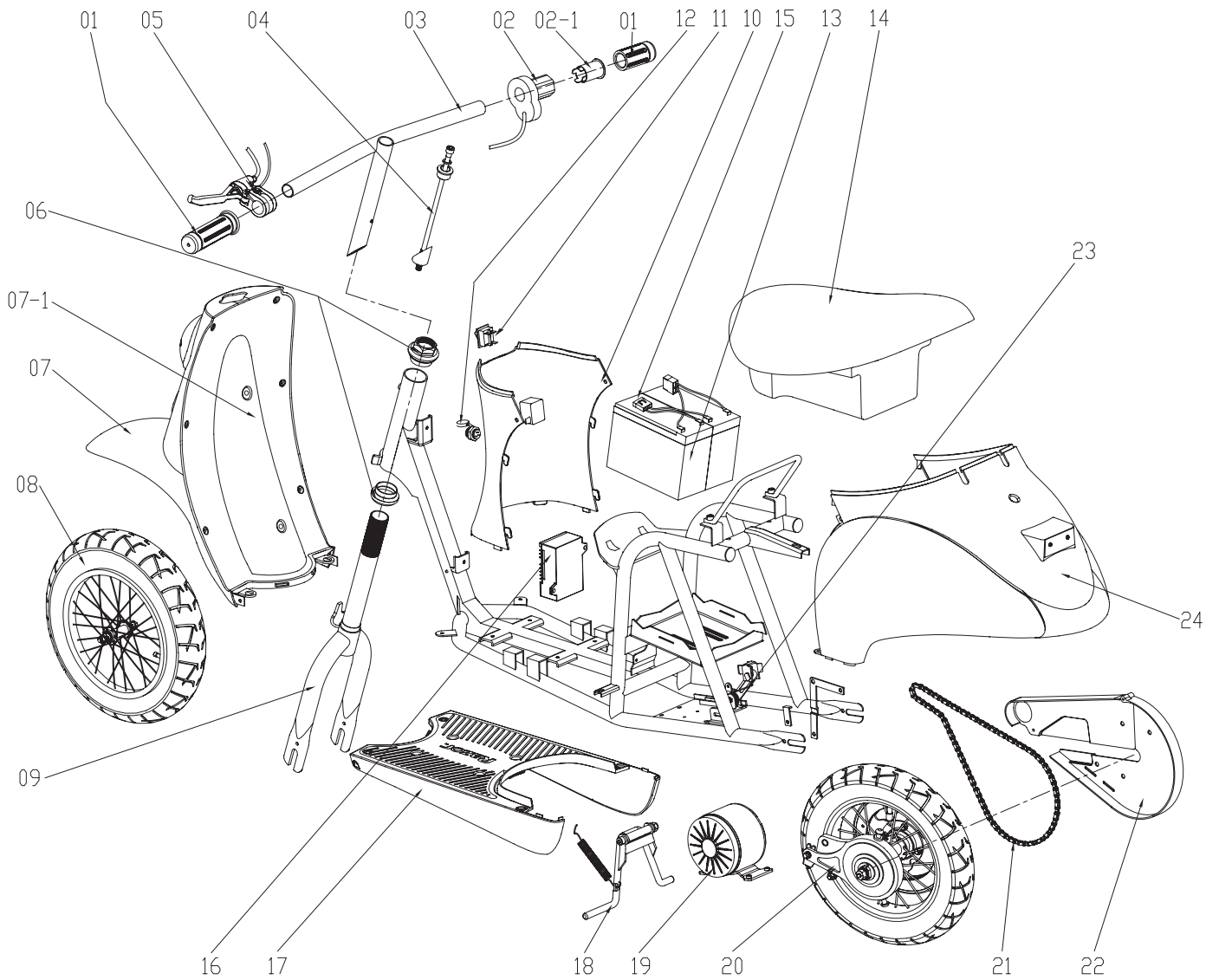

**Need Help?** Visit our website for updates and a list of authorized service centers at [www.razor.com](http://www.razor.com) or call toll-free at 866-467-2967 Monday - Friday 8:00 AM - 5:00 PM Pacific Time.

**SB 1918 (CALIFORNIA) DECLARATION**

YOUR INSURANCE POLICIES MAY NOT PROVIDE COVERAGE FOR ACCIDENTS INVOLVING THE USE OF THIS SCOOTER/ELECTRIC RIDE-ON PRODUCT. TO DETERMINE IF COVERAGE IS PROVIDED, YOU SHOULD CONTACT YOUR INSURANCE COMPANY OR AGENT.

## SAFETY REMINDERS

### PRE-RIDE CHECKLIST



#### Loose Parts

There should not be any unusual rattles or sounds from loose parts or broken components. If you are not sure, ask an experienced mechanic to check or call customer service.



#### Brake

Check the brake for proper function. When you squeeze the lever, the brake should provide positive braking action. When you apply the brake with the speed control on, the brake cut-off switch will stop the motor.



#### Frame, Fork and Handlebars

Check for cracks or broken connections. Although broken frames are rare, it is possible for an aggressive rider to run into a curb or wall and wreck, bend or break the frame. Get in the habit of inspecting your product regularly.



#### Tire Inflation

Periodically inspect the tires for excess wear and replace as needed. Regularly check the tire pressure and inflate as needed. If you get a flat tire, the inner tube can be patched or a new tube can be purchased from Razor or an authorized repair center.



#### Safety Gear

Always wear proper protective equipment such as an approved safety helmet. Elbow pads, kneepads, pants and long sleeves are recommended. Always wear shoes, never ride barefooted or in sandals, and keep shoelaces tied and out of the way of the wheels, motor and drive system.



## DO NOT RETURN TO STORE

Do not use this product for the first time until you have inflated the tires to the correct PSI and charged the battery for at least 12 hours.

Failure to follow these instructions may damage your product and void your warranty.

## WARRANTY

### Razor Limited Warranty

The manufacturer warrants this product to be free of manufacturing defects for a period of 90 days from date of purchase. This Limited Warranty does not cover normal wear and tear, tires, tubes, cables, or any damage, failure or loss caused by improper assembly, maintenance, storage or use of the Razor Pocket Mod.

This Limited Warranty will be void if the product is ever:

- used in a manner other than for recreation;
- modified in any way;
- rented.

The manufacturer is not liable for incidental or consequential loss or damage due directly or indirectly to the use of this product.

Razor does not offer an extended warranty. If you have purchased an extended warranty, it must be honored by the store at which it was purchased.

For your records, save your original sales receipt with this manual and write the serial number below. The serial number is located on the bottom of the frame directly under the motor.

Item Number:

<b>Bella</b>	<b>15130610</b>
<b>Betty</b>	<b>15130661</b>
<b>Daisy</b>	<b>15130650</b>
<b>Vapor Black</b>	<b>15130601</b>
<b>Vapor Silver</b>	<b>15130612</b>
<b>Sweet Pea</b>	<b>15130659</b>
<b>Little Red</b>	<b>15130658</b>
<b>Hello Kitty</b>	<b>15130664</b>
<b>Kiki</b>	<b>15130634</b>

**Need Help?** Visit our website for updates and a list of authorized service centers at [www.razor.com](http://www.razor.com) or call toll-free at 866-467-2967 Monday - Friday 8:00 AM - 5:00 PM Pacific Time.

Patent Pending  
Printed in China for:  
Razor USA LLC  
PO Box 3610  
Cerritos, CA 90703

Copyright © 2003 - 2011 Razor USA LLC. All rights reserved. RAZOR and the Razor Logo Design are among the registered trademarks of Razor USA LLC in the United States and/or select foreign countries. Pocket Mod is a trademark of Razor USA LLC.